

ALMATEC®

Expert
for the Solutions
Semiconductor
Industry

FUTUR Series

Where Innovation Flows

AIR-OPERATED DOUBLE-DIAPHRAGM PUMPS

a **DOVER** company

almatec.de



FUTUR at a Glance

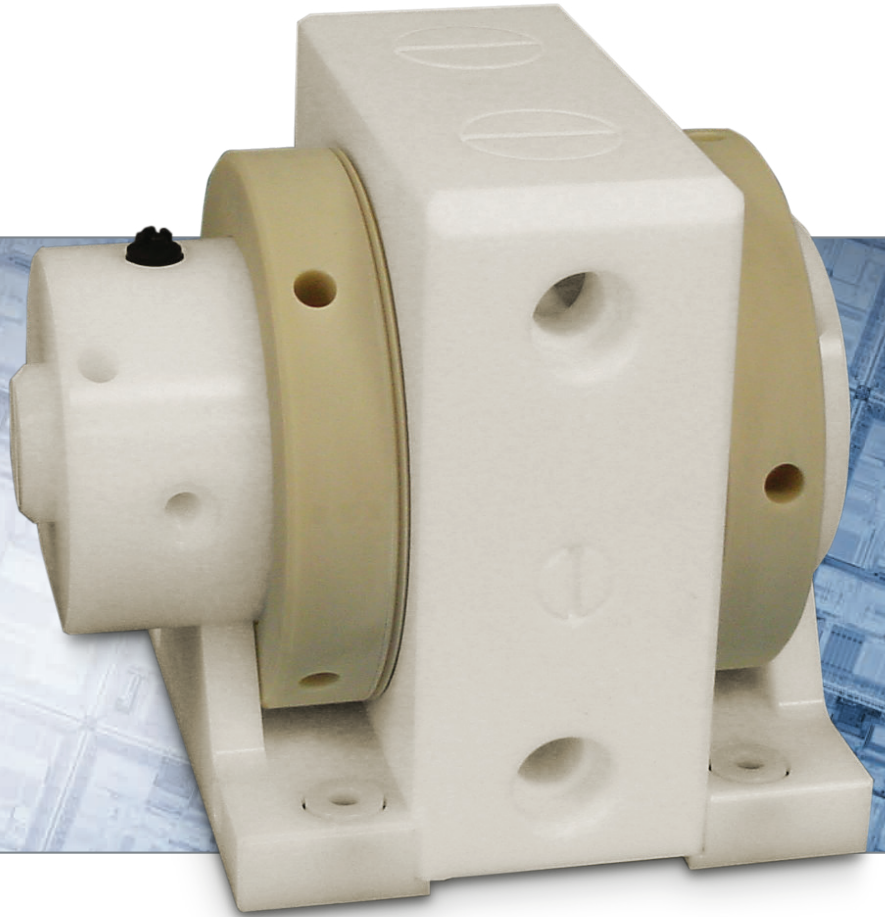

- Three material versions (T, H and E) for different applications
- All models contain no metal
- Temperature range up to 200°C/392°F (H)
- Patented, contactless cascade sealing between the product chambers
- No O-ring sealing in wetted areas
- Straight-through flow pattern, only one wetted housing part
- PERSWING P® air control system requires no lubrication or maintenance
- Internal air flow
- Diaphragms without plates and gaskets, optimized diaphragm geometry
- Cylinder valves with surface sealing
- Compact, simple design with few parts, very low space required
- Machined from solid blocks
- Easy to dismantle and assemble
- No elements to fix, such as tie rods, nuts, or clamps
- Separate pulsation damper available for all materials and sizes
- Diaphragm and/or stroke sensors can be retrofitted easily
- Low noise level
- Assembled in a clean-room line

Highlights of Design



Since 1991 Almatec manufactures pumps of the FUTUR family, which are designed specifically for chemical supply and circulation in the semiconductor industry. The liquids handled in the semiconductor industry have different demands, requiring a unique pump to meet those demands. Today the 4th and 5th generations of Futur pumps were manufactured.

FUTUR Series pumps are self-priming air-operated diaphragm pumps which have the capability to run dry. The liquid flows straight through the product chambers of the center housing, while the air control system and the air chambers are located in the side housing. This design ensures that only one part of the housing comes in contact with the liquid, reduces the number of flow bends to only two, minimizes the surface area, eliminates sliding parts in the product chambers, and makes it possible to dispense with gaskets. There are no fastening elements, such as tie rods, clamps, or nuts. The patented, contactless cascade sealing between the product chambers is a major structural element that eliminates the problem of sliding surfaces in the liquid with respect to particles generation and increased dry-run sensitivity.

FUTUR pumps have a compact, simple design with few parts. The housing parts are machined from solid blocks, resulting in long-life operation. Suction and discharge ports are located at the front, thus simplifying installation in confined spaces.

In the wetted area of the FUTUR pumps there is no O-ring sealing.

The pumps can be easily controlled via the air volume.



Model Overview



MODEL FUTUR T

When delivering acids and caustics, corrosion resistance is of the highest importance, so the center housing is constructed of special PTFE-TFM. Compared to normal PTFE, it has a higher tensile strength and surface density. Parts made of this material are smooth and free of pores, which results in reduced particle generation. The pumps are absolutely metal-free and can be used in temperature ranging up to 130°C (266°F).

Applications

- Acids
- Caustics
- High purity chemicals

Materials

- Center housing: PTFE-TFM
- Side housings: Polyethylene

Pump Sizes & Performance

- 10T (10 l/min / 2.6 gpm)
- 20T (20 l/min / 5.3 gpm)
- 50T (50 l/min / 13 gpm)
- 100T (100 l/min / 26 gpm)

MODEL FUTUR E

The FUTUR E model has been designed to be abrasion-resistant, which is a requirement for pumping slurries. To meet these operational demands, they are constructed of PE (polyethylene). It has a very high abrasion resistance (higher than steel), good impact value and withstands the introduction of slurry particles. Its good chemical properties allow handling both basic and acidic slurries. The FUTUR E is metal-free, with a maximum permitted liquid temperature of 70°C (158°F).

Applications

- Basic slurries
- Acidic slurries

Materials

- Center housing: Polyethylene
- Side housings: Polyethylene

Pump Sizes & Performance

- 20E (20 l/min / 5.3 gpm)
- 50E (50 l/min / 13 gpm)



MODEL

FUTUR H

Metal-free FUTUR H pumps have been designed to operate ideally in hot applications involving acids and caustics. The temperature limit is 200°C (390°F) at max. 2 bar (29 psig).

Applications

- Hot applications with acids
- Hot applications with caustics

Materials

- Center housing: PTFE-TFM
- Side housings: PTFE conductive

Pump Sizes & Performance

- 10H (10 l/min / 2.6 gpm)
- 20H (20 l/min / 5.3 gpm)

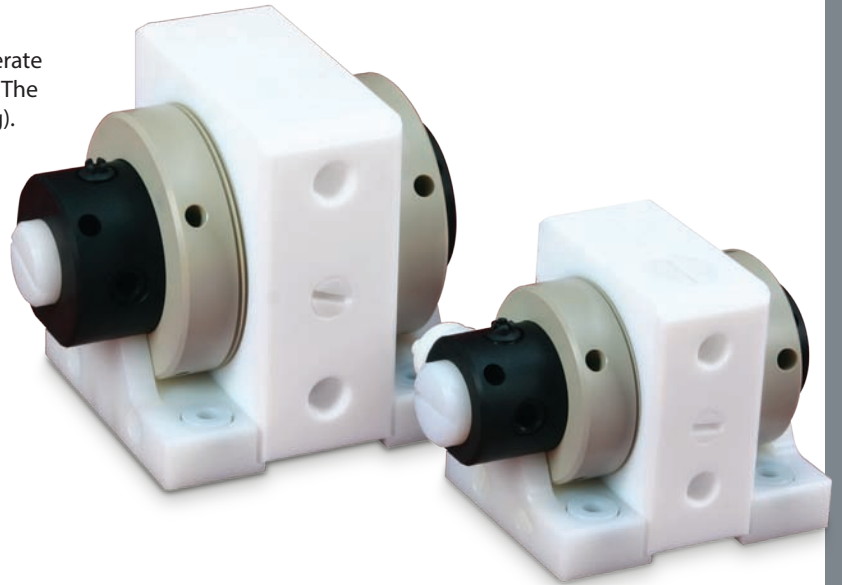

MODEL

FUTUR Omega

The FUTUR Omega model is the 5th generation of FUTUR pumps. It is entirely constructed of PTFE-TFM, with the option of polyethylene or 316L stainless-steel construction.

New design elements are the Ω -shaped base frame and the rotation prevention of the diaphragm and the center housing. Furthermore, an optimized PTFE diaphragm material is used.

Applications

- High-end semiconductor

Materials

- Center housing: PTFE-TFM
 - Side housings: PTFE-TFM
- (Also available in polyethylene and SS316L materials)

Pump Sizes & Performance

- FO 20 (20 l/min / 5.3 gpm)
- FO 50 (50 l/min / 13 gpm)
- FO 100 (100 l/min / 26 gpm)

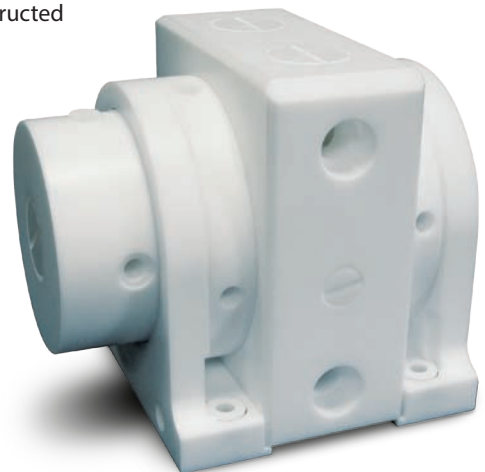

Pulsation Dampers and Special Equipment

Due to their design, oscillating displacement pumps deliver a pulsating flow. This pulsation is considerably reduced by utilizing the appropriately designed air distribution channels and chambers of the FUTUR series, as well as by the cascade seal. Pulsation dampers (type D) of the same design without tie rods are available for all pump materials and sizes, if the remaining pulsation on the discharge side is unacceptable for a specific application. The installation of a pulsation damper is quick and easy, as it is simply screwed on top of the pump. Therefore, a separate pulsation damper can be retrofitted at any time, even on installed pumps, without changing the product connections.

FUTUR pumps can be fitted with a sensor installed in the muffler to monitor the diaphragms and a pneumatical stroke counter. A pressure transmitter registers the changes in pressure within the air chamber behind the diaphragm on the left-hand side.

Suction and discharge ports on the plastic FUTUR pumps can optionally be equipped with Flaretek® connectors for the piping system.

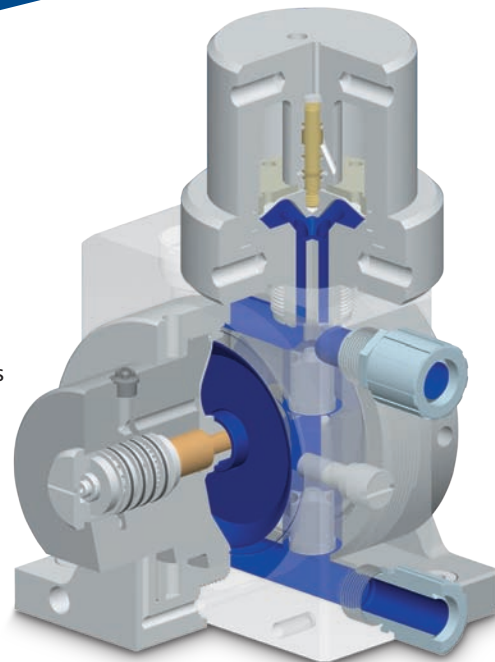

Diaphragms and Cylinder Valves

Neither piston plates nor gaskets are required for the diaphragms made of PTFE. The well-balanced geometry leads to an extremely long lifetime. The wetted surface is small, and does not contain any pockets in which particles may accumulate. In this respect, the FUTUR diaphragms differ considerably from sensitive bellows with their large surface.

The pumps are equipped with the tried-and-tested cylinder valves. These valves seal a large area and ensure very good dry priming. They close gently and evenly and permit accurate delivery. In contrast to the FUTUR many competitive pumps are equipped with ball valves. Ball valves form a linear seal with the valve seat. Moreover the closing process can be delayed by the twisting motion of the ball. The result is irregular operation.



The PERSWING P® Air Control System

The main piston is accurately switched by the built-in air control system PERSWING P®. The pilot piston is decoupled from the diaphragm stroke and is operated only then at the end of the stroke like an indirect air control. There are no external controllers, limit switches and wiring. The patented PERSWING P® air control system does not require maintenance, operates without lubrication, and is characterized by a low noise level during operation.

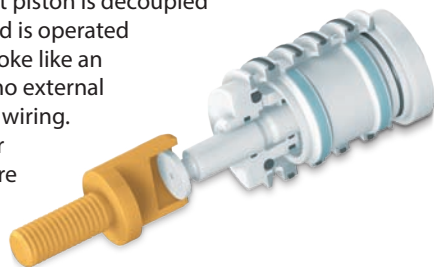

Clean Room Assembly

All FUTUR pumps are cleaned several times, assembled, and tested in a clean-room line.



Technical Data

		Data			
Pump size		10	20	50	100
Dimensions for pump in mm (inch),	length	185 (7.3)	201 (7.9)	246 (9.7)	303 (11.9)
	width	114 (4.5)	150 (5.9)	200 (7.9)	260 (10.2)
	height	131 (5.2)	168 (6.6)	216 (8.5)	266 (10.5)
Dimensions for pump with damper in mm (inch),	length	185 (7.3)	201 (7.9)	246 (9.7)	303 (11.9)
	width	136 (5.4)	161 (6.4)	215 (8.5)	286 (11.3)
	height	246 (9.7)	283 (11.1)	348 (13.7)	429 (16.9)
Nominal port size (NPT)		3/8"	1/2"	1"	1 1/4"
Air connection (NPT)		1/4"	1/4"	1/4"	1/4"
Suction head, dry in mWC (ft.)		1 (3.3)	2.5 (8.2)	3.5 (11.5)	4 (13.1)
Suction head, wet in mWC (ft.)		8 (26.2)	9 (29.5)	9 (29.5)	9 (29.5)
Max. permissible driving pressure bar (psig)		6 (87)	6 (87)	6 (87)	6 (87)

Max. permitted operating temperature			
Pump model	FUTUR H	FUTUR T	FUTUR E
at max. 6 bar (87 psig)	100°C 212°F	100°C 212°F	70°C 158°F
at max. 5 bar (73 psig)	130°C 266°F	110°C 230°F	70°C 158°F
at max. 4 bar (58 psig)	150°C 302°F	120°C 248°F	70°C 158°F
at max. 3 bar (44 psig)	180°C 356°F	130°C 266°F	70°C 158°F
at max. 2 bar (29 psig)	200°C 392°F	130°C 266°F	70°C 158°F

Performance Range

The specified performance data are warranted by ALMATEC in accordance with DIN EN ISO 9906 as far as applicable. The data refers to water. The blue lines state the air consumption.

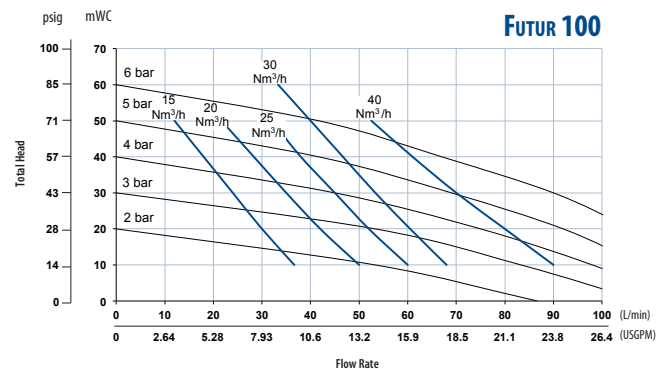
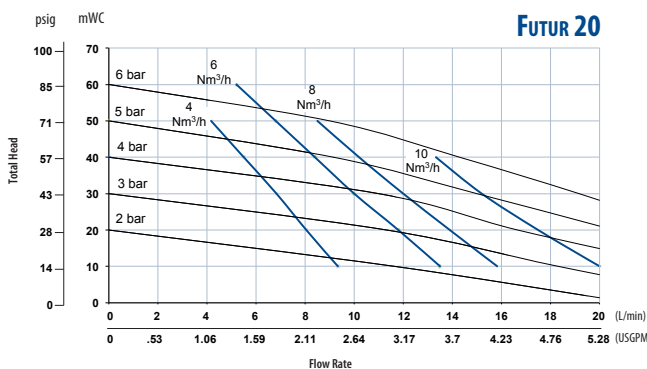
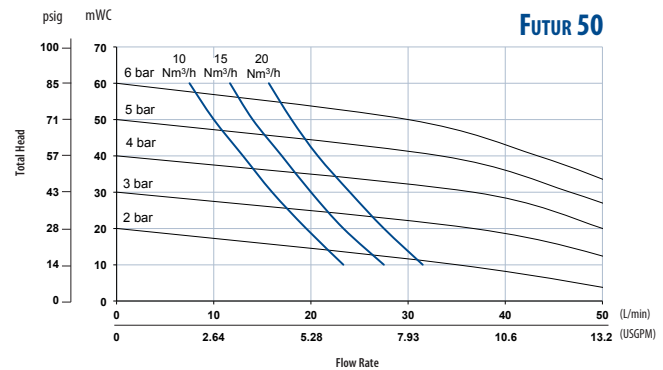
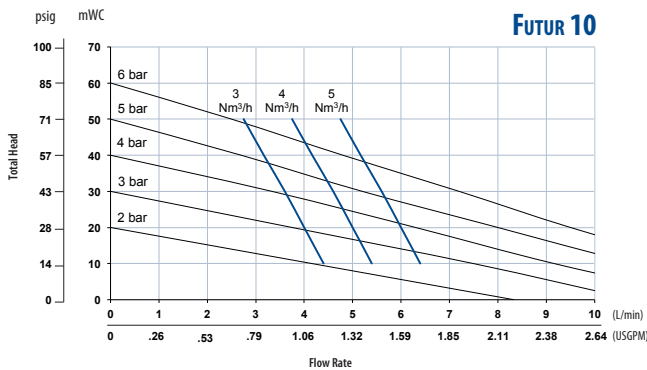



Where Innovation Flows

ALMATEC

Almatec Maschinenbau GmbH
Carl-Friedrich-Gauß-Straße 5
47475 Kamp-Lintfort, Germany
T: +49 (0) 2842/961-0
F: +49 (0) 2842/961-40
info@almatec.de
almatec.de

PSG reserves the right to modify the information and illustrations contained in this document without prior notice. This is a non-contractual document. 11-2016

Authorized PSG Partner:

